

BOLLY® 1 ST

POLYWARM® COATED DOMESTIC HOT WATER CALORIFIER WITH 1 FIXED HEAT EXCHANGER



APPLICATION

Production and storage of domestic hot water (DHW).

MATERIAL

Mild steel Polywarm® coated (Attestation ACS - SSICA - DVGW - W270 - WRAS)

HEAT EXCHANGER

Mild steel Polywarm® coated heat exchanger.

INSULATION

- HARD: High thermal insulation with ecological polyurethane hard foam.

- SOFT: NOFIRE® polyester fleece 100% made of recyclable material, with high thermal insulation. Fire resistance class B-s2d0 according to EN 13501. Grey PVC external lining.

CATHODE PROTECTION

Magnesium anode.

DRAIN

External confluence through drain connection. Models > 500 External confluence through drain connection.

GASKET- FLANGE PLATE

Silicone gaskets suitable for water intended for human consumption (tested according to 98/83/CE), max temperature up to 200°C. Mild steel inspection flange plate with Polywarm®.

WARRANTY

5 years - See general sales conditions and warranty

ACCESSORIES AND SPARE PARTS

See Accessories section for the entire list.

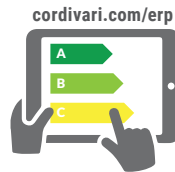
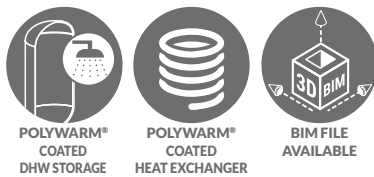

On line ErP label tool



BOLLY® 1 ST WB

Model	HARD FOAM insulation Art. Nr.	HEAT EXCHANGER SURFACE [m ²]	ENERGY EFFICIENCY CLASS ErP
150	3105162321101	0,6	B
200	3105162321102	0,8	B
300	3105162321103	1,2	B
400	3105162321104	1,5	C
500	3105162321105	1,8	C
800	3104162331106	2,7	B
1000	3104162331107	3,5	B
1500	3104162331108	3,8	C



BOLLY® 1 ST WC

Model	DISMOUNTABLE SOFT FLEECE insulation Art. Nr.	HEAT EXCHANGER SURFACE [m ²]	ENERGY EFFICIENCY CLASS ErP
800	3103162321136	2,7	C
1000	3103162321137	3,5	C
1500	3103162321138	3,8	C

ACCESSORIES

ELECTRIC IMMERSION HEATERS

Mod.	MONOPHASE		
	1,5 kW	2 kW	3 kW
	5240000000051	5240000000052	5240000000053
	Ignition time from 10 °C to 45 °C with electric immersion heaters [min]		
150	42	76	57
200	72	128	96
300	113	202	152
400	167	299	225
500	184	329	247
800	313	560	420
1000	383	686	514
1500	557	998	749

THREEPHASE				
4 kW	5 kW	6 kW	9 kW	12 kW
5240000000047	5240000000048	5240000000049	5240000000050	5240000000031
Ignition time from 10 °C to 45 °C with electric immersion heaters [min]				
//	//	//	//	//
//	//	//	//	//
//	//	//	//	//
//	//	//	//	//
//	//	//	//	//
257	206	171	114	86
374	299	250	166	125

"Easy Control" Electronic Display-mounted on tank

ART. NR.	FOR MODELS
5005000310002	WC
5005000310003	WB

Electric immersion heater flange plate

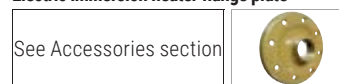

Titanium electronic anode

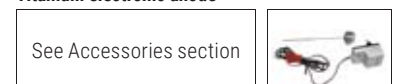

BOLLY® 1 ST

POLYWARM® COATED DOMESTIC HOT WATER CALORIFIER WITH 1 FIXED HEAT EXCHANGER

Model	STORAGE		HEAT EXCHANGER	
	Pmax	Tmax	Pmax	Tmax
150 ÷ 800	10 bar	90 °C	12 bar	110 °C
1000 ÷ 1500	8 bar			



CORDIVARI® Lab

TÜV Rheinland Energie und Umwelt GmbH states that test procedures and Cordivari LAB are certified conforming to European standard EN 15332, as indicated by Ecodesign ErP Directive.

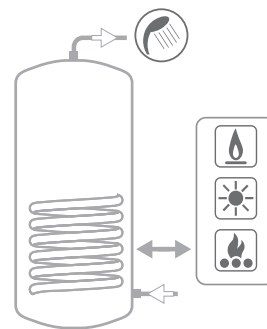

A	Domestic hot water outlet
B	Recirculation
C	Connection for instrumentation 1/2" F
D	Connection for electric immersion heater
E	Connection for magnesium anode 1"1/4 F
F	Lower heat exchanger inlet 1"1/4 F
G	Lower heat exchanger outlet 1"1/4 F
K	Blind flange for inspection
M	Domestic cold water circuit inlet
N	Connection for instrumentation 1/2" F
O	Drain 1" 1/4 F For models < 500
P	Drain for models > 500

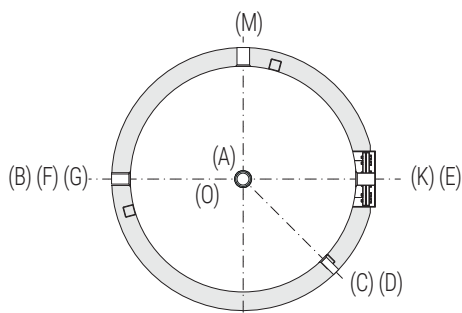
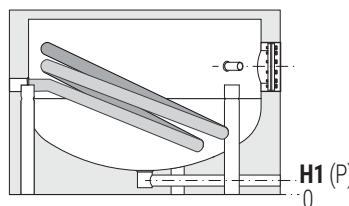
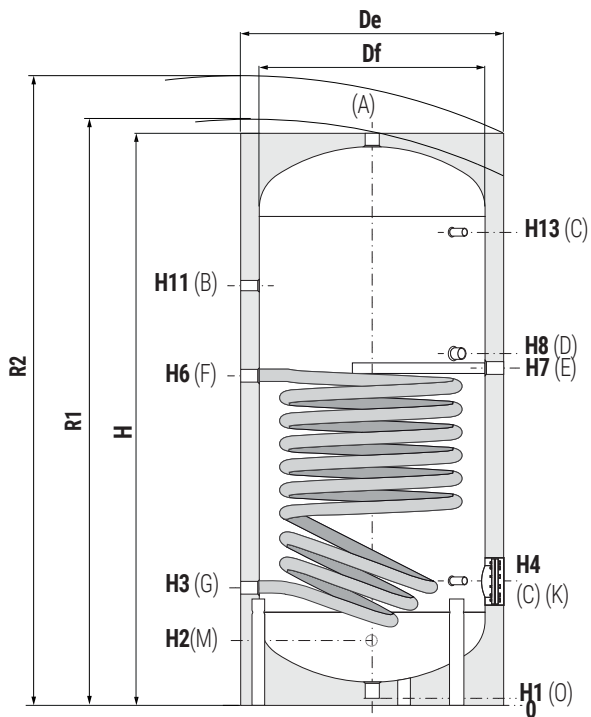

Model	Volume [lt]	Weight [Kg]	Df	De	De	R1	R2	H	H1	H2	H3
			(vers. WC)	(vers. WC)	(vers. WB)	(vers. WC)					
150	148	49	//	//	500	//	1500	1414	70	210	275
200	189	55	//	//	550	//	1536	1434	70	220	285
300	291	67	//	//	650	//	1622	1486	70	246	311
400	422	88	//	//	700	//	1900	1766	70	261	326
500	498	120	//	//	750	//	1937	1786	70	271	346
800	789	184	750	950	900	2200	2343	2163	101	493	428
1000	1038	215	850	1050	1000	2265	2432	2217	89	524	439
1500	1443	389	950	1150	1100	2495	2680	2440	109	450	425

Model	H4	H6	H7	H8	H11	H13	K	P	M	D	B	A
150	315	759	815	885	1065	1185	Øi120/Øe180	-	3/4"	1"1/2	3/4"	1"1/4
200	325	811	855	915	1089	1195	Øi120/Øe180	-	3/4"	1"1/2	3/4"	1"1/4
300	381	832	871	931	1101	1221	Øi120/Øe180	-	1"	1"1/2	1"	1"1/4
400	396	988	1033	1091	1286	1486	Øi120/Øe180	-	1"	1"1/2	1"	1"1/4
500	411	1036	1076	1144	1331	1476	Øi120/Øe180	-	1"	1"1/2	1"	1"1/4
800	483	1181	1243	1308	1598	1788	Øi170/Øe240	3/4"	1"	2"	1"	1"1/4
1000	499	1279	1309	1364	1584	1819	Øi170/Øe240	3/4"	1"1/4	2"	1"	1"1/2
1500	575	1403	1450	1515	1825	2065	Øi300/Øe380	1"	1"1/2	2"	1"	2"



Data have been calculated on following basis:

- 1) Primary circuit at T1 and proper energy source;
- 2) Production of DHW in continuous way from 10 °C at t2;
- 3) DHW that can be taken in the first 10' and in the first hour from storage at 60°C, input 10°C and output 45°C;
- 4) Sanitary water according to UNI CTI 8065.

LOWER
HEAT EXCHANGER

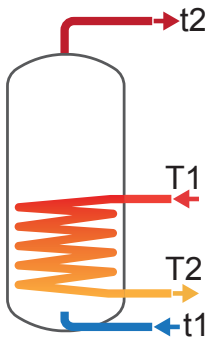

Model	Primary Flow rate [m³/h]	Ignition time (minutes) from 10 °C to t2 and primary at T1				Maximum power exchange (kW) with primary at T1, secondary within 10-45 °C and constant use of DHW production				DHW continuous production lt/h within 10-45 °C and primary at T1			
		T1/t2				T1				T1			
		55/50	65/60	70/60	80/60	55	65	70	80	55	65	70	80
150	2	99	102	71	46	6,6	10	11,7	15,2	162	246	288	371
	1	111	116	81	53	6,1	9,1	10,6	13,2	149	223	260	336
200	2,5	92	95	66	43	9	13,5	15,8	20,5	220	332	389	506
	1,25	103	107	75	49	8,3	12,3	14,4	18,5	203	303	354	456
300	3	97	101	70	45	13,5	20,2	23,6	30,6	331	498	583	756
	1,5	106	111	78	51	12,5	18,5	21,5	27,5	307	455	529	680
400	3,5	105	110	76	50	16,9	25,4	29,6	38,3	416	625	731	947
	1,75	117	122	86	57	15,4	23,2	26,9	34,5	387	571	664	853
500	3,5	111	116	81	53	20,2	30,1	35,1	45,3	496	742	867	1121
	1,75	126	131	93	61	18,7	27,3	31,7	40,6	459	674	782	1000
800	6	116	120	84	55	30,3	45,4	53	68,6	746	1120	1309	1695
	3	131	136	96	64	28,2	41,4	48,1	61,6	692	1021	1186	1521
1000	6	114	119	84	56	38,9	57,9	67,5	87	958	1429	1667	2151
	3	132	138	98	65	35,5	52,2	60,4	77	882	1288	1492	1903
1500	6	162	168	119	78	41	61	71	91,5	1009	1504	1753	2261
	3	189	197	139	92	37,7	54,9	63,4	80,7	927	1352	1564	1993

Model	Primary Flow rate [m³/h]	DHW produced in the first 10 minutes in lt/10' input 10 °C output 45 °C, storage at t2 and primary at T1				DHW produced in the first hour in lt/60' input 10 °C output 45 °C, storage at t2 and primary at T1				Heat exchanger pressure loss	
		T1/t2				T1/t2				[mm H ₂ O]	[mbar]
		55/50	65/60	70/60	80/60	55/50	65/60	70/60	80/60		
150	2	195	251	258	272	298	407	440	507	218,85	21,46
	1	193	247	253	266	287	388	418	479	60,62	5,95
200	2,5	253	325	335	354	392	536	581	675	441,12	43,26
	1,25	250	321	329	346	378	512	553	635	122,19	11,98
300	3	388	499	513	542	597	814	882	1021	927,45	90,95
	1,5	384	492	504	529	578	780	839	960	256,91	25,19
400	3,5	550	706	723	759	814	1101	1186	1359	1480,67	145,20
	1,75	546	697	712	744	791	1058	1133	1284	410,16	40,22
500	3,5	651	834	855	897	965	1304	1404	1607	1850,84	181,50
	1,75	645	822	840	877	935	1249	1336	1510	512,70	50,28
800	6	1026	1314	1345	1410	1499	2023	2174	2483	1538,50	150,87
	3	1017	1297	1325	1381	1455	1944	2076	2344	426,18	41,79
1000	6	1345	1720	1759	1840	1952	2625	2815	3202	1994,35	195,58
	3	1332	1696	1730	1799	1891	2512	2675	3004	552,45	54,18
1500	6	1870	2378	2419	2504	2509	3330	3530	3936	2108,31	206,75
	3	1856	2352	2388	2459	2443	3209	3378	3722	584,02	57,27

HEAT EXCHANGERS PRESSURE LOSS

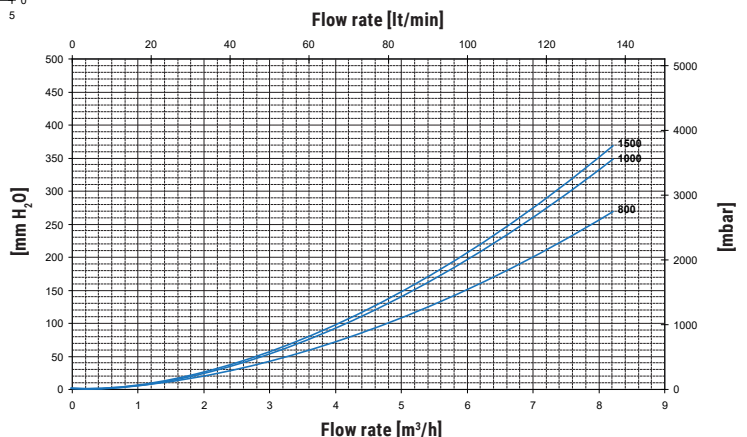
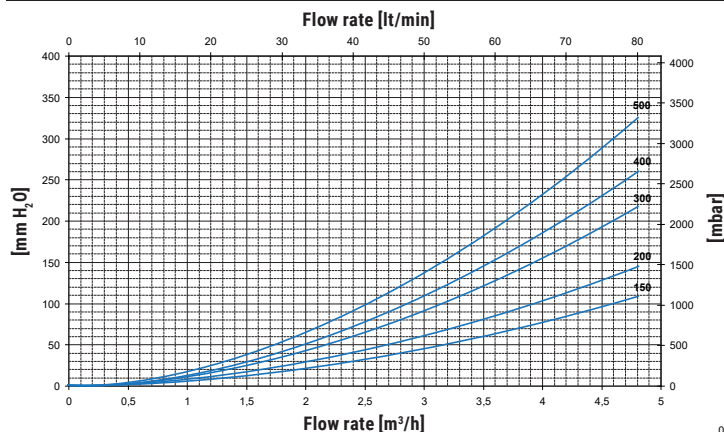

BOLLY® 1 ST

HEAT EXCHANGERS TECHNICAL DATA



Heat Exchanger output referred to temperature and flow rate of primary circuit and with secondary at 10/45°C at maximum withdrawal of producible DHW (Upper limit of the curves referred to maximum primary flow rate in the heat exchanger, while the lower limit in the curves refer to the minimum primary flow rate).

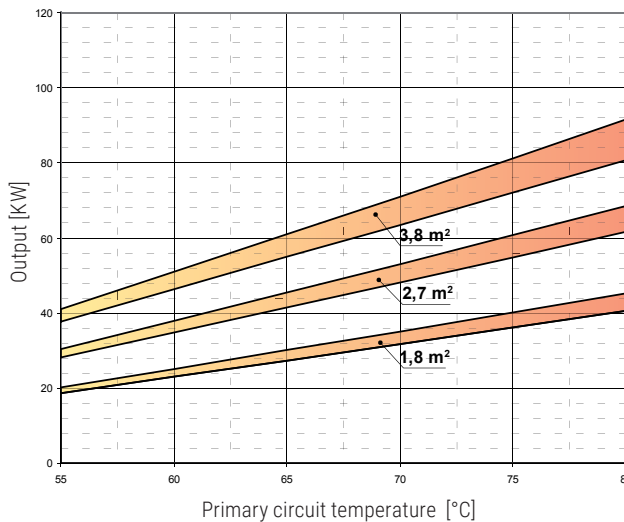
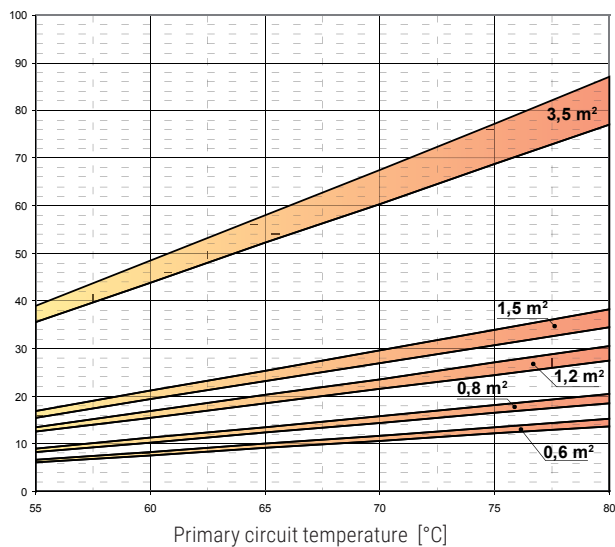

Heat exchanger surface	0,6 m ²		0,8 m ²		1,2 m ²		1,5 m ²		3,5 m ²	
	MAX	MIN	MAX	MIN	MAX	MIN	MAX	MIN	MAX	MIN
Flow rate [m ³ /h]	2	1	2,5	1,25	3	1,5	3,5	1,75	6	3

Heat exchanger surface	1,8 m ²		2,7 m ²		3,8 m ²	
	MAX	MIN	MAX	MIN	MAX	MIN
Flow rate [m ³ /h]	3,50	1,75	6	3	6	3

EXAMPLE OF INSTALLATION WITH BOLLY® 1 ST

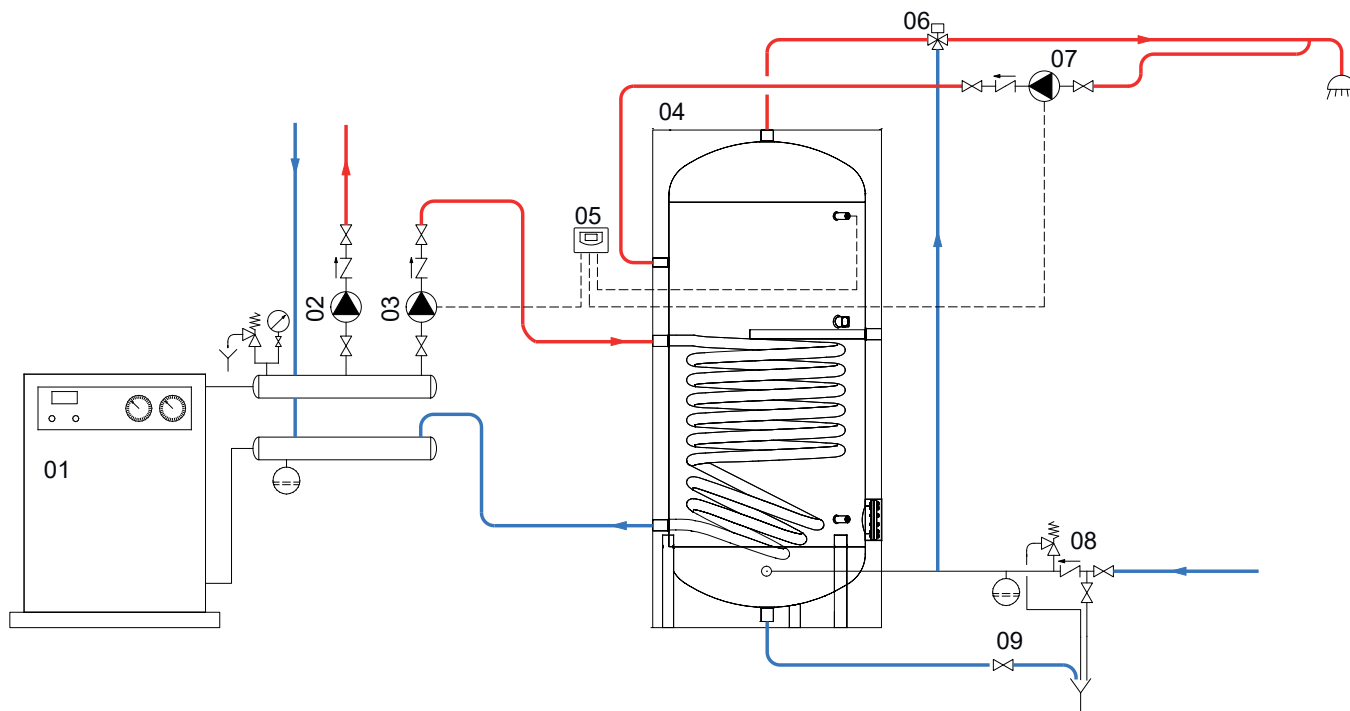

01 Generator	04 BOLLTY® 1 ST	07 D.H.W. recirculation group
02 Heating system circulation group	05 Easy Control electronic display/thermostat	08 Hydraulic safety group
03 D.H.W. circulation group	06 Thermostatic mixing valve	09 Blowdown valve